

## Track Components

### START FROM HERE

- Make sure **POWER** is **COMPLETELY OFF** at the fuse box
- Have your fixture installed by a qualified licensed electrician
- Prepare everything in a clear area
- Wear gloves at all time during this installation
- Read instructions carefully before you start assembly
- Keep this installation sheet for future reference

**Technical Support:** 1-855-855-8926

**Please Note:**

- All Trilo Track System parts sold separately

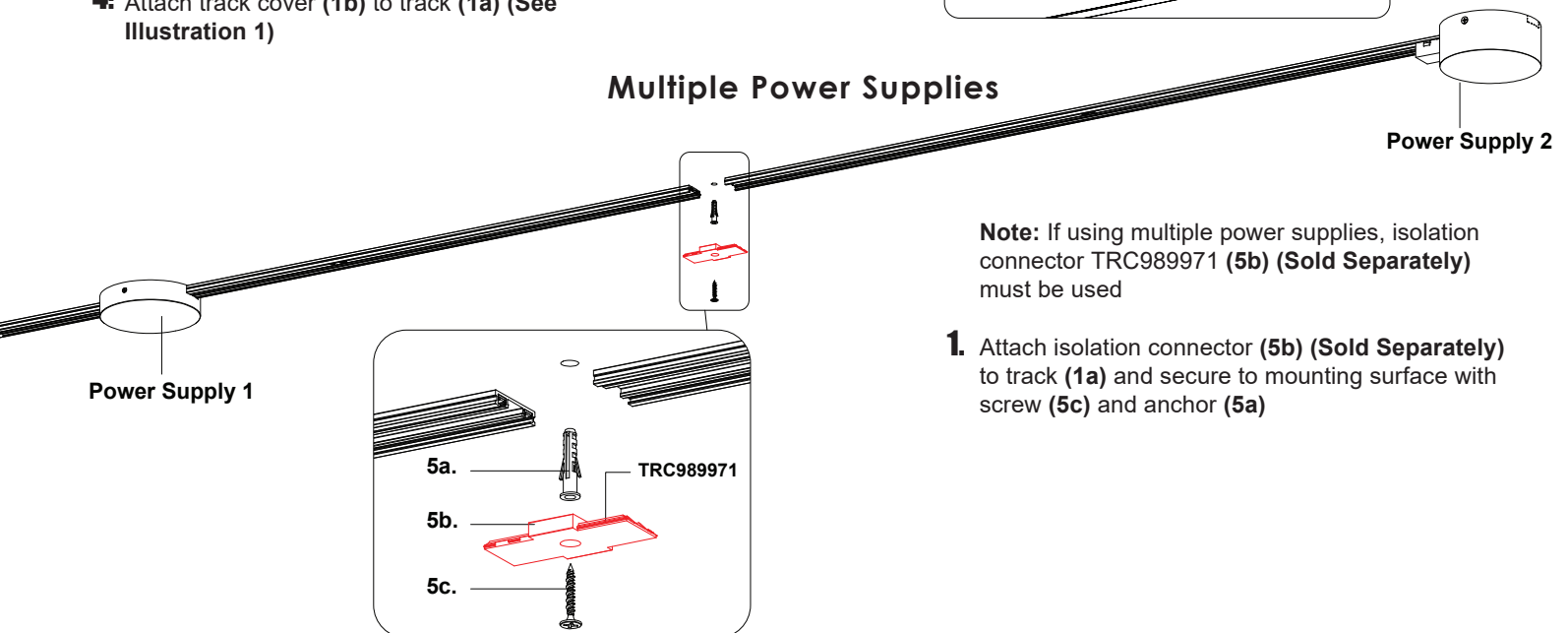
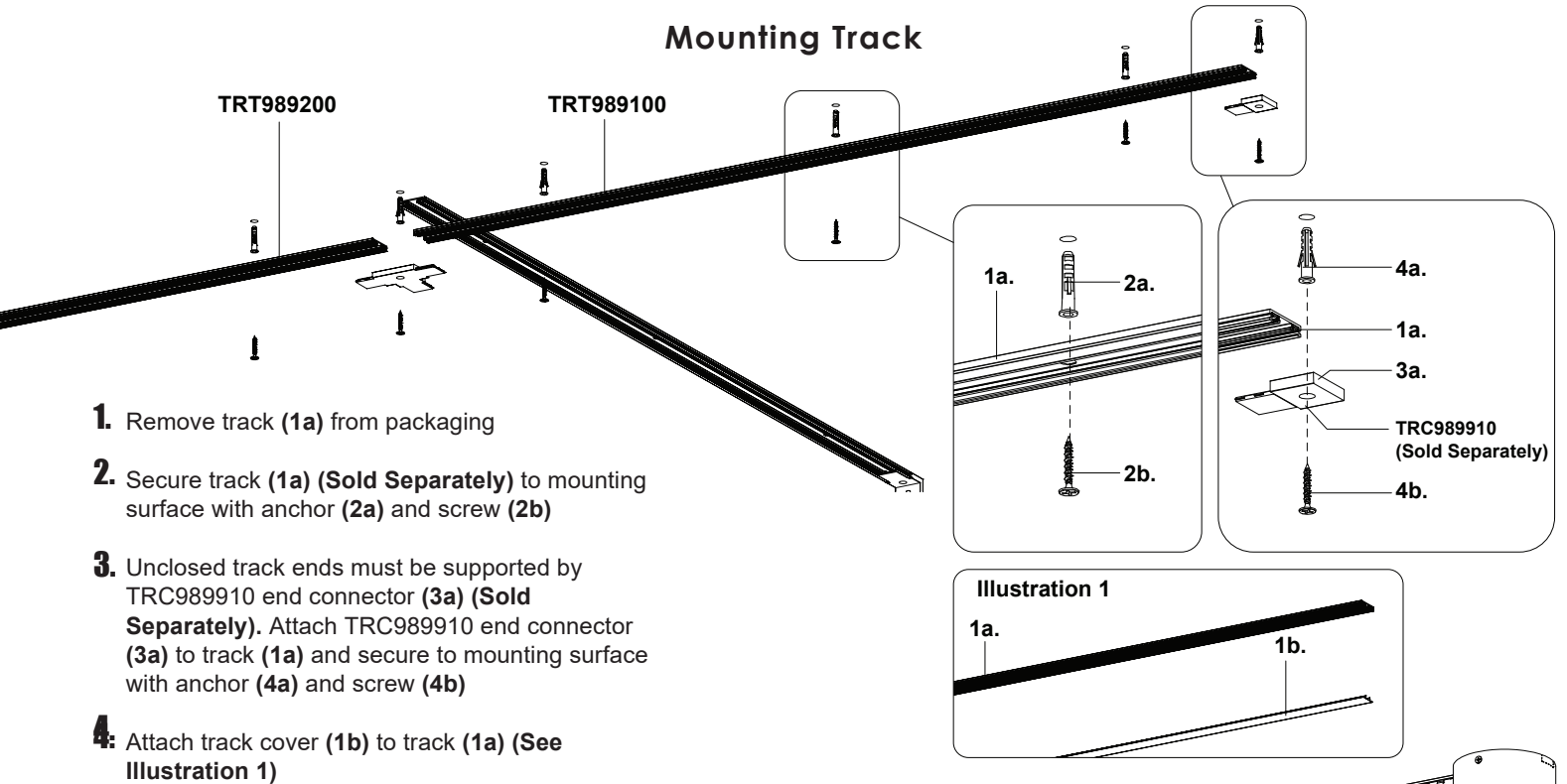

**Note:** If using multiple power supplies, isolation connector TRC989971 (5b) (Sold Separately) must be used

**KUZCO**

19054 28th Avenue Surrey, BC Canada V3Z 6M3  
T: 604 538 7162 TF: 1-855 85 KUZCO F: 604 538 7196  
W: kuzcolighting.com  
20240910

# Track Components

## START FROM HERE

- Make sure **POWER** is **COMPLETELY OFF** at the fuse box
- Have your fixture installed by a qualified licensed electrician
- Prepare everything in a clear area
- Wear gloves at all time during this installation
- Read instructions carefully before you start assembly
- Keep this installation sheet for future reference

**Technical Support:** 1-855-855-8926

**Please Note:**

- All Trilo Track System parts sold separately

## Connecting Track Components Together

TRC989123

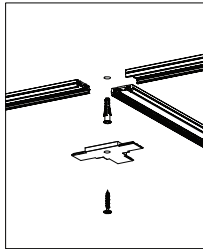

TRC989112

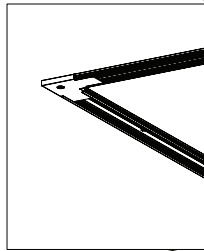
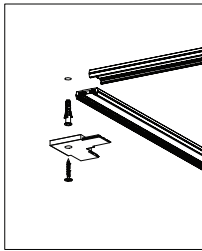

TRC989134

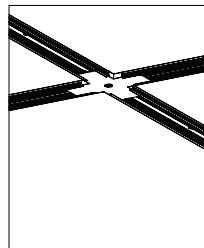
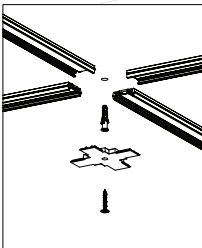

TRC989011

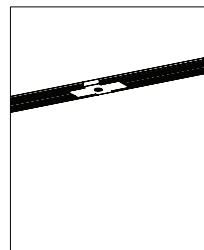
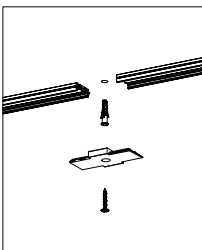

TRC989022  
(Ceiling to Wall Connector)

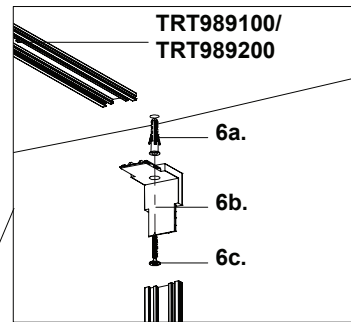

1. Remove track connector(s) (6b) (Sold Separately) from packaging
2. Attach track connector(s) (6b) to track and secure to mounting surface with anchor (6a) and screw (6c)